

**BASE GROUP**



# BASE

**PAVING SUPPLIES**

NATURAL STONE | PORCELAIN | BESPOKE

2023-24



# BASE

PAVING SUPPLIES  
*Limited*



---

NATURAL STONE | PORCELAIN | BESPOKE

---- OUR COLLECTIONS ----

*If lockdown taught us one thing, it was the importance of having a safe space that we can enjoy!*

**OUR VISION:** to be the premier supplier of natural stone & porcelain in the UK, of which customers can purchase materials with full understanding of how they can enhance or create beautiful, tranquil spaces without having to spend thousands. Buy from us with confidence and be sure that we genuinely care about your project.



**JACK WELLS | MANAGING DIRECTOR**

Hello and welcome to Base. Firstly I'd like to thank all those who have contributed to this brochure and look forward to supporting them once again.

With the unprecedented times we've seen in the past few years; the pandemic, brexit and even the Suez Canal, the priority was to raise stock levels to ensure customer's projects didn't halt. We heard many stories last year of long waiting times, some competitors waiting times as long as three months. I was adamant I'd do all I could for that not to happen with us. With that I'm pleased to say we now have distribution centres in; Oxfordshire, Felixstowe, Southampton and Knutsford, meaning lead times for stocked materials are generally between 2-5 days.

With a brand new site in Abingdon, South Oxfordshire. The new site sees us move into a stunning unit comprising of an external display area of 250m<sup>2</sup>, an internal swimming pool coping showroom, sales office and reception area with free refreshments and quiet space so you can make informed, unpressed decisions.

We look forward to welcoming you and hope you find this brochure informative.

---

Welcome	4
Our Carbon Footprint	6
Showrooms & Distribution	8
Customer Favourites	10
Porcelain	14
British Stone	24
Imported Stone	30
Swimming Pool Copings	36
Bespoke Services	50
Internal Tiles	56
Product Sourcing	58
The Gallery...	60

---

A marvellous effort from Jack and his team to turn around our pool coping in just 10 days. We were sadly let down by another company after receiving their sample to be told lead time was 6 weeks, with the liner booked in we needed copings fast. Jack, through all my scepticism after being let down already elsewhere gave me updates throughout the process and delivered on time. Highly recommended the service and the product we chose was porcelain. It's lovely and as Jack described hard pushed to tell it apart from a natural stone

**Ben Withnell - Pool Project**

Excellent service from Jack and his team at Base on our recent swimming pool project. They managed to deliver the order in less than two weeks including bullnosing all the copings and corners, no one else could offer less than 6 weeks. Quality of porcelain perfect and price competitive. Many thanks to Base and would highly recommend

**Linda Powell - Bespoke Pool Project**

# OUR CARBON FOOTPRINT



Since opening, our aim has always been to lower not just our carbon footprint, but the entire industries'. It's no secret that since the early 90's Indian sandstones have saturated the UK market, although it's got better there is still a lot of work to do.

## NO DESIGNATED COMPANY LORRY?



We have made a conscious decision to not own our own vehicle for deliveries. Director Jack Wells speaks highly of the third party haulier services available to us in this country, *"With companies such as PalletTrack and Palletways operating nationwide we're incredibly lucky that pallets can be moved around the UK in as little as 24 hours. I don't see the need to further add to the environmental crisis when such services already exist"*. Locally we use a company called AFFA who are based just 4 miles away from our head office.

Also due to us having distribution centres strategically placed around popular UK docks (Southampton, Felixstowe & Knutsford), there are always couriers in passing ensuring no further vehicles need to be assigned for any deliveries we may have. That's why we have a strict cut off time for next day deliveries.

# OUR CARBON FOOTPRINT



We ensure across all our distribution centres that electric forklifts are used to reduce the consumption of petroleum and diesel.

Across all sites any stock that is damaged is marked down as such and offered at discounted prices available for customers, this saves on material being disposed of unnecessarily.

**FOR  
SALE**



Grouped deliveries. Our logistics team at the end of each day check requested delivery dates of each customer and group together collections to ensure the load is full.

Leasing staff electric vehicles where possible and installing charging points across all sites.



We're proud to offer one of the biggest selections of British and Irish natural stone, while also supporting local quarries across Oxfordshire and neighbouring counties.

We appreciate there is still plenty we can do to further lower our carbon footprint, however, as a family business we're proud of the steps we've made and will continue to strive to be better. Here is a reminder to check out our British Stone Range - we have spent a considerable amount of time to build a collection that is not just beautiful but can also help you do your bit to save our planet.

# ABINGDON SHOWROOM

and distribution centres

"We're based in East Sussex so we called for pool copings on a whim after being let down and not wanting to lose our contractors. Jack sent copings on the Wednesday and they arrived Friday AM ensuring we didn't fall behind! Very thankful."

**Adam Dyer - Happy Customer!**





# ABINGDON SHOWROOM

and distribution centres

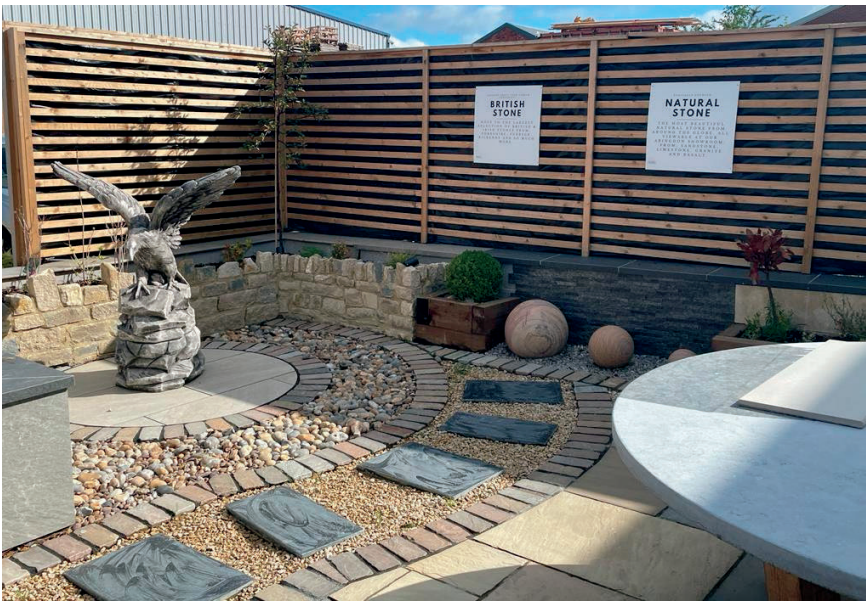

We moved to our new display centre and sales office in September 2022. Abingdon-on-Thames is a beautiful historic market town in South Oxfordshire, with our centre perfectly located on the Eyston industrial estate, where we share the road with Screwfix, B&Q and Abingdon Storage. The popular A34 Marcham interchange is just 0.54 miles from our front door, linking both the M40 and M4, ensuring customers can visit our impressive show areas with ease.

Once you arrive at our Abingdon HQ, you can relax in our personalised customer area, offering free refreshments, television and sofas to allow you to take time while making informed decisions. After all, there is a lot to see at Base!



# OUR MOST SOUGHT AFTER PRODUCTS

by Base.

Although we're always adding new products to follow market trends, we have some items that can't help but be in the thick of it. Browse just a few of our top picks and stay informed with what's popular.

# LAMBELLE

Antico Limestone



Specially sourced by Director Jack Wells, it is no surprise at all that our Lambelle Antico Limestone is without doubt the most sought after Natural Stone product. Quarried on the edge of the beautiful and popular city of Sharm El-Sheikh, Lambelle is a dense limestone, beige bodied with natural grey fossils and pearls nestled in the surface.

Due to it's popular demand we offer it in many variations, from different size paving, pool copings and internal tiles.

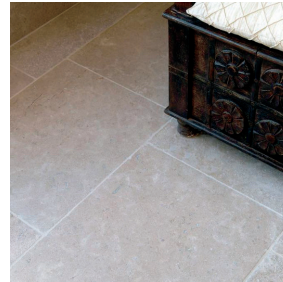

Due to it's density, unlike many natural stones, sealant is not a necessity - we would only recommend a water-based impregnator sealer should the customer wish to deepen the surface appearance, giving the tile a 'wet look' all year round.

Lambelle is not to be compared to cheaper Egyptian Limestones, often mentioned are 'Dijon', and 'Jaipur' which are inferior options to that of our Lambelle. The entire process of how we quarry, cut and finish our product is what creates the important differences. How we cut into the seam of a block to ensure less porosity, therefore making it denser, the process of tumbling, acid etching and semi polishing is what gives us our unique surface, in which, doesn't take away any of it's natural beauty, but does make it suitable for the UK climate and a safe slip resistance.

## LAMBELLE PRODUCT VARIATIONS

Swimming Pool Copings	Paving Options	Tile Options
600 x 300 x 20-50 Downstand edge 600 x 300 x 40 Bullnose edge Matching Corners	900 x 600 x 22 Tumbled 600 x 600 x 22 Tumbled 200/100 x 100 x 40 Setts 200 x 40 x 50 Pavers	900 x 600 x 18 Antiqued 600 x 600 x 18 Antiqued 600 x 300 x 18 Antiqued

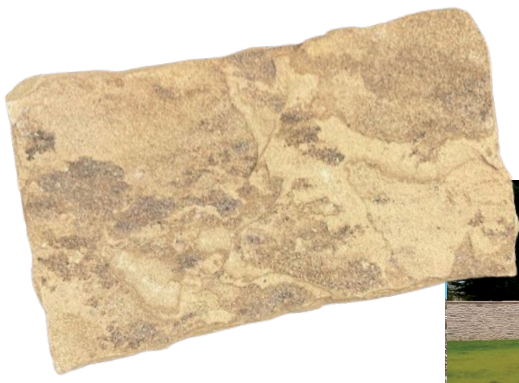

# YORK STONE

NEW RIVEN, RECLAIMED & SAWN

We pride ourselves on offering the UK's biggest selection of British Stone, and in-particular York Stone. This hard wearing Sandstone has been used up and down high streets for hundreds of years.

With so many beautiful variations of York stone, we work direct with quarries across Yorkshire and Lancashire to bring you the very best material, as well as having our own partner quarry in Huddersfield.



Most commonly we're renown for supplying the highest quality Reclaimed York Stone. Offering both Cathedral Grade and Grade 'A', our reclaimed stone is always supplied with provenance and confidence that it will be free of oil staining and milling, while personally checking each stone ensuring only the best bits make the final pallets!

We offer New Riven York paving , New Sawn York paving as well as multiple bespoke capabilities from; pool copings, steps, threads, stone pillars, rills and plenty of others! With the pandemic putting strains on import more people have turned to our beautiful isle stones and it's been a long time coming!

## YORK STONE VARIATIONS

Reclaimed	New Riven Paving	New Sawn Paving	Swimming Pool Copings (Sawn)
R x R x R Cathedral R x R x R Grade A R = Random	600 x R/L x 40 R/L = Random Length	600 x R/L x 50 or Specific Size Peices	1000 x 300 x 50 bullnose or Bespoke Sizes

# CASTELLO

Grigio Porcelain



Like all our porcelain, designed by and created for Base Paving, Castello Grigio is a full bodied, R11 anti slip tile which works in an array of settings.

Available in the popular 1200 x 600 large format tile, it brings a real aesthetic feel to your project. Offering stocked, matching bullnose copings it's understandable why the pool industry seems to love it so much. As seen in the pictures, when laid together it creates a contemporary, minimalistic

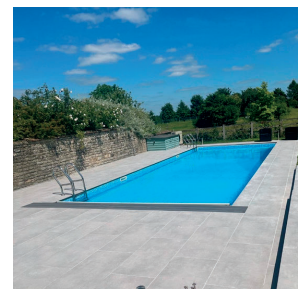

feel which is hard to replicate. We often get asked whether all porcelain is the same, and simply put, no. Like natural stone many factors will cause different finishes and qualities. We always tell customers to be careful when purchasing cheaper porcelain tiles often found in 'tile warehouses' or local builders merchants. Our's are created to ensure longevity without colour variance and maintenance, due to the low water absorbency of our porcelain we can offer larger guarantees against colour change, algae, lichen and other annoying natural issues often found in natural stone. Finishing all our tiles with an anti-slip matt coating makes them perfect for external use around a pool or patio without the worry of accidents!

Our guarantee is an unbeatable 25 years! That's how we know we offer the highest grade porcelain.

## CASTELLO GRIGIO VARIATIONS

Swimming Pool Copings	Paving Options
1200 x 330 x 20 Bullnose edge Bespoke Coping Options Matching Corners	1200 x 600 x 20 600 x 600 x 20





A photograph of an outdoor patio area. In the background, there is a grey outdoor sofa with several patterned cushions in shades of yellow, green, and blue. The patio floor is paved with large, light-brown rectangular porcelain tiles. In the foreground, a path of smaller, square porcelain tiles is set in a bed of grey gravel, leading towards the sofa. To the right, there is a green plant in a grey planter box.

# EXTERNAL PORCELAIN PAVING

by **BASE**

We're confident that we have created a collection of porcelain options that offer a variation of colour palettes, sizes, and styles while ensuring quality is paramount. By offering not just our own cost effective range solely for **BASE** but popular brand porcelain, customers have choices and can make informed decisions best suited to their project.



Ciatna Anthracite 900x600x20



Castello Grigio 1200x600x20



Cemento Dark 900x600x20





Liassidi Creme 900x600x20



Florence White 900x600x20

# PORCELAIN

WHAT AM I?



Porcelain is a man-made material created by baking a mixture of clay, sand and other minerals. These are then put into a high-temperature kiln. From this, an incredibly durable and non-porous material is created, known as porcelain. The benefits to porcelain are huge and since 2015 has taken the UK market by storm, it's hard, non-porous surface means it's highly durable, resistant to moss and lichen which you often find on natural stone and therefore is easy to maintain with minimal amounts of maintenance. Our range is frost resistant, slip resistant, approved to the highest standards and we offer unlimited creativity.

Most Popular



## CASTELLO GRIGIO PORCELAIN

**Provenance:** Turkey

**Options Available:** 1200x600x20,  
600x600x20, Bullnose copings, Bespoke  
capabilities.

**Finish:** Matt

**Slip Rating:** R11



## FLORENCE WHITE PORCELAIN

**Provenance:** Turkey

**Options Available:** 900x600x20,  
Bullnose copings,  
Bespoke capabilities.

**Finish:** Matt

**Slip Rating:** R11



## CIATNA ANTHRACITE PORCELAIN

**Provenance:** Turkey

**Options Available:** 900x600x20,  
Bullnose copings,  
Bespoke capabilities.

**Finish:** Matt

**Slip Rating:** R11



## LIASSIDI CREME PORCELAIN

**Provenance:** Turkey

**Options Available:** 900x600x20,  
Bullnose copings,  
Bespoke capabilities.

**Finish:** Matt

**Slip Rating:** R11



## ST.MARKS GRIGIO PORCELAIN

**Provenance:** Turkey

**Options Available:** 900x600x20,  
600x600x20, Bullnose copings,  
Bespoke capabilities.

**Finish:** Matt

**Slip Rating:** R11

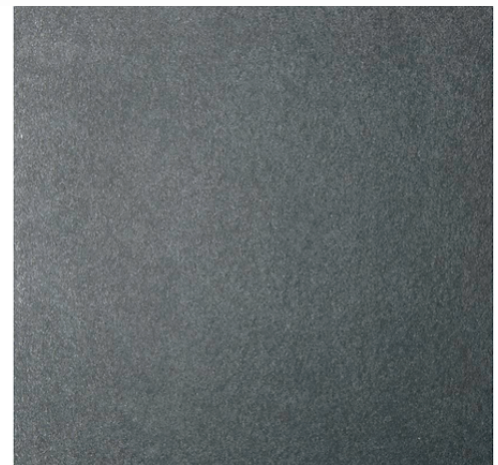

## MURANO DARK PORCELAIN

**Provenance:** India

**Options Available:** 900x600x20,  
600x600x20, Bullnose copings,  
Downstand copings,  
Bespoke capabilities.

**Finish:** Matt

**Slip Rating:** R11



## BALFONT GREY PORCELAIN

**Provenance:** Turkey

**Options Available:** 900x600x20,  
Bullnose copings,  
Bespoke capabilities.

**Finish:** Matt

**Slip Rating:** R11

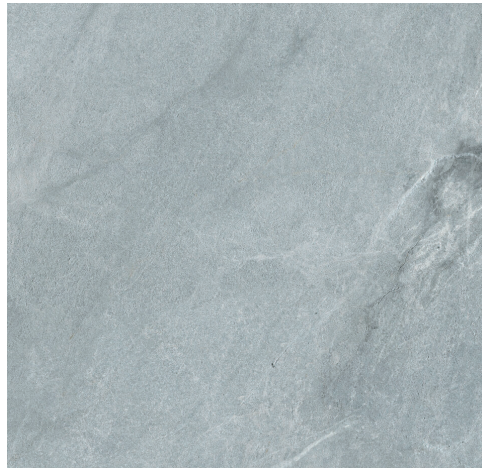

## QUARTZ GREY PORCELAIN

**Provenance:** India

**Options Available:** 900x600x20,  
Bespoke capabilities.

**Finish:** Matt

**Slip Rating:** R11



## MOCHAWOOD PLANK PORCELAIN

**Provenance:** Turkey

**Options Available:** 1200x300x20,  
Bespoke capabilities.

**Finish:** Matt

**Slip Rating:** R11



## SILVERWOOD PLANK PORCELAIN

**Provenance:** Turkey

**Options Available:** 1200x300x20,  
Bespoke capabilities.

**Finish:** Matt

**Slip Rating:** R11

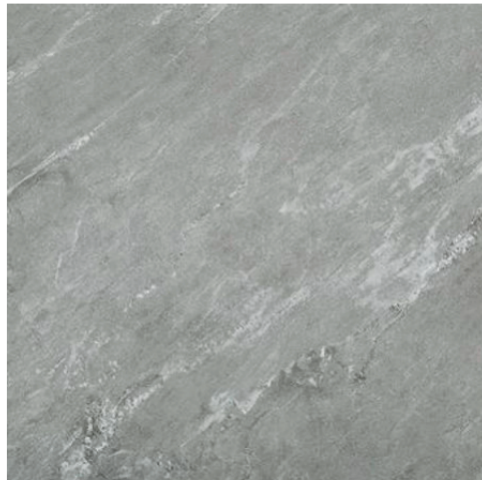

## QUARTZO MARBLE GRIGIO PORCELAIN

**Provenance:** Italy

**Options Available:** 900x600x20,  
Bespoke capabilities.

**Finish:** Matt

**Slip Rating:** R11



## QUARTZ WHITE PORCELAIN

**Provenance:** India

**Options Available:** 900x600x20,  
Bespoke capabilities.

**Finish:** Matt

**Slip Rating:** R11



**PIAZZA BLUE  
PORCELAIN**

**Provenance:** India

**Options Available:** 900x600x20,  
600x600x20, Pool coping,  
Bespoke capabilities.

**Finish:** Matt

**Slip Rating:** R11



**BURLINGTON SILVER  
PORCELAIN**

**Provenance:** India

**Options Available:** 900x600x20,  
600x600x20, Bespoke capabilities.

**Finish:** Matt

**Slip Rating:** R11



**PIAZZA CREME  
PORCELAIN**

**Provenance:** India

**Options Available:** 900x600x20,  
600x600x20, Bespoke capabilities.

**Finish:** Matt

**Slip Rating:** R11



**CAIRO BEIGE  
PORCELAIN**

**Provenance:** India

**Options Available:** 900x600x20,  
Bespoke capabilities.

**Finish:** Matt

**Slip Rating:** R11



**CEMENTO GREY  
PORCELAIN**

**Provenance:** Turkey

**Options Available:** 900x600x20,  
600x600x20, Bullnose copings,  
Bespoke capabilities.

**Finish:** Matt

**Slip Rating:** R11



**BURLINGTON IVORY  
PORCELAIN**

**Provenance:** India

**Options Available:** 900x600x20,  
Bespoke capabilities.

**Finish:** Matt

**Slip Rating:** R11



## PIAZZA BEIGE PORCELAIN

**Provenance:** India

**Options Available:** 900x600x20,  
600x600x20, Pool coping,  
Bespoke capabilities.

**Finish:** Matt

**Slip Rating:** R11



## KANDLA SILVER PORCELAIN

**Provenance:** India

**Options Available:** 900x600x20,  
Bespoke capabilities.

**Finish:** Matt

**Slip Rating:** R11



## PIAZZA GREY PORCELAIN

**Provenance:** India

**Options Available:** 900x600x20,  
600x600x20, Pool coping,  
Bespoke capabilities.

**Finish:** Matt

**Slip Rating:** R11



Castello Bullnose steps 1200x330x20

# BUY OUR PORCELAIN ONLINE

Using our stunning e-commerce  
website

Simple and easy to use, get your project underway in just a click!

[www.basepaving.co.uk](http://www.basepaving.co.uk)

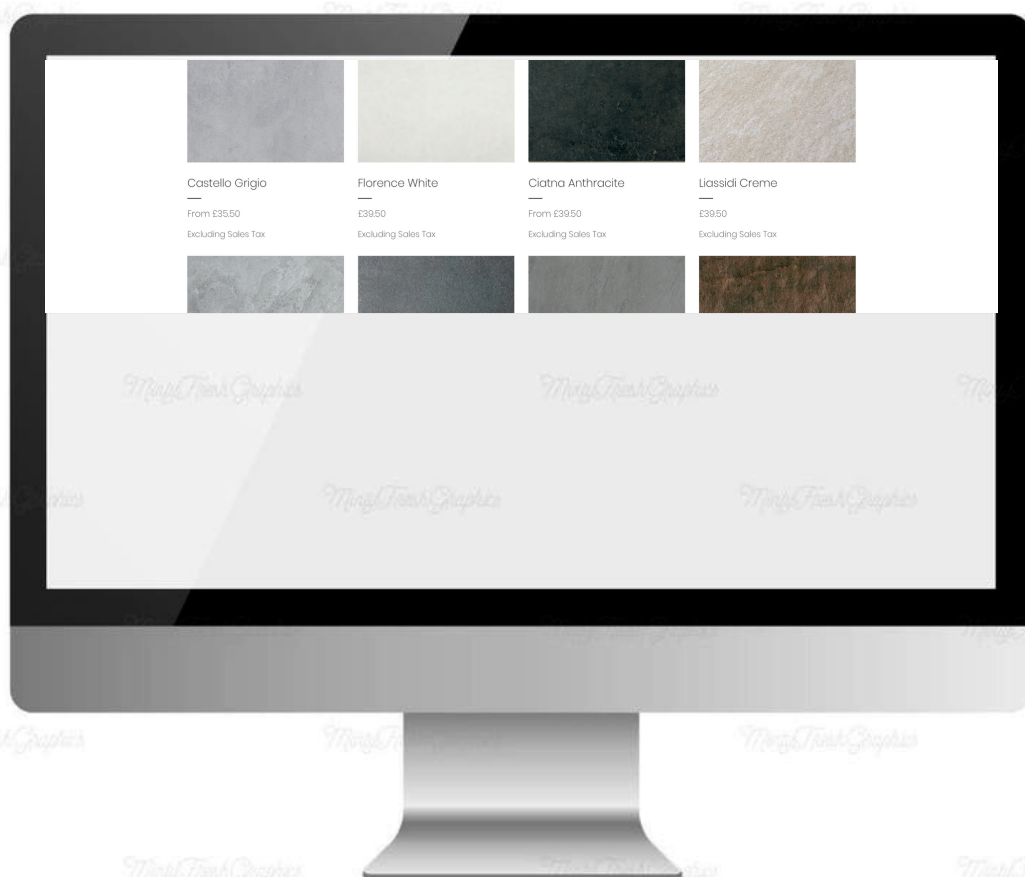

Hampton Court Palace. Director Jack Wells consulted and supplied on Hampton Courts redevelopment of the Pavilion House.





# BRITISH STONE

by BASE



We're proud at Base to offer the biggest selection of British Stone. Up and down Britain and Ireland we work with quarries to ensure the highest quality materials are available at your door. Most known for our huge selection of York Stone, we offer new, reclaimed, paving and multiple bespoke possibilities.



Grade A Reclaimed York stone



Reclaimed York Stone laid at Watlington Park Manor

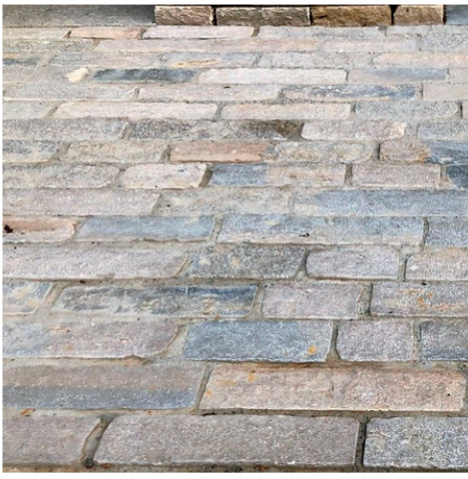

## **CHARMINSTER PURBECK SETTS**

**Provenance:** Dorset, UK

**Options Available:** 250- x100x30-50, Bespoke capabilities.

**Finish:** Riven

**Slip Rating:** R13



## **ASHMORE TEXTURE PURBECK PAVING**

**Provenance:** Dorset, UK

**Options Available:** R/WxR/Lx30-50, Bespoke capabilities.

**Finish:** Riven

**Slip Rating:** R13



## **CHARMINSTER RIVEN PURBECK PAVING**

**Provenance:** Dorset, UK

**Options Available:** 300xR/Lx30-50, Bespoke capabilities.

**Finish:** Riven

**Slip Rating:** R13



## **BABBINGTON PORTLAND STONE**

**Provenance:** Dorset, UK

**Options Available:** 500xR/Lx30, Bespoke capabilities.

**Finish:** Natural, Honed

**Slip Rating:** R11

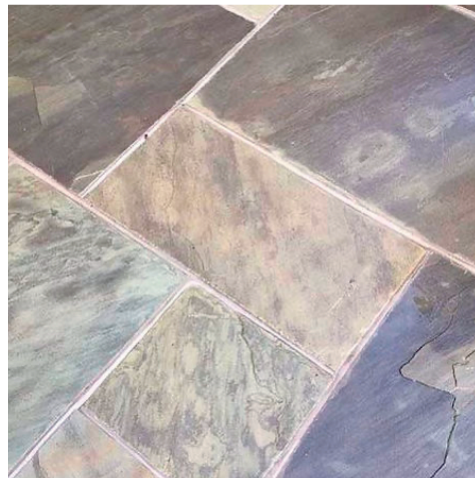

## **SELF FACED NEW RIVEN YORK STONE**

**Provenance:** Yorkshire, UK

**Options Available:** 600xR/Lx30-50, Bespoke capabilities.

**Finish:** Riven

**Slip Rating:** R13



## **NEW RIVEN MORLEY YORK STONE**

**Provenance:** Lancashire, UK

**Options Available:** 600xR/Lx30-50, Bespoke capabilities.

**Finish:** Riven

**Slip Rating:** R13





**GRADE CATHEDRAL  
RECLAIMED YORK STONE**

**Provenance:** UK

**Options Available:**

Random.

Varies from each demolition

**Finish:** Riven

**Slip Rating:** R13

**GRADE A' RECLAIMED  
YORK STONE**

**Provenance:** UK

**Options Available:**

Random.

Varies from each demolition

**Finish:** Riven

**Slip Rating:** R13

**RECLAIMED GRANITE  
SETTS**

**Provenance:** UK

**Options Available:**

Random.

Varies from each demolition

**Finish:** N/a

**Slip Rating:** R13



**RECLAIMED YORK  
STONE COBBLES**

**Provenance:** UK

**Options Available:**

Random.

Varies from each demolition

**Finish:** N/a

**Slip Rating:** R13



**SKIPTON SAWN  
YORK STONE**

**Provenance:** Lancashire, UK

**Options Available:** 600xR/Lx50,

Bespoke capabilities.

**Finish:** Sawn

**Slip Rating:** R13





# IMPORTED STONE

by **BASE**

There has been a huge need for imported natural stones in the UK for some time, commonly, Indian sandstone is the most regarded. We have carefully selected some of the worlds most beautiful natural stones, while ensuring all ethical trade polices are adhered to in offering a collection of stone fit for various different projects.

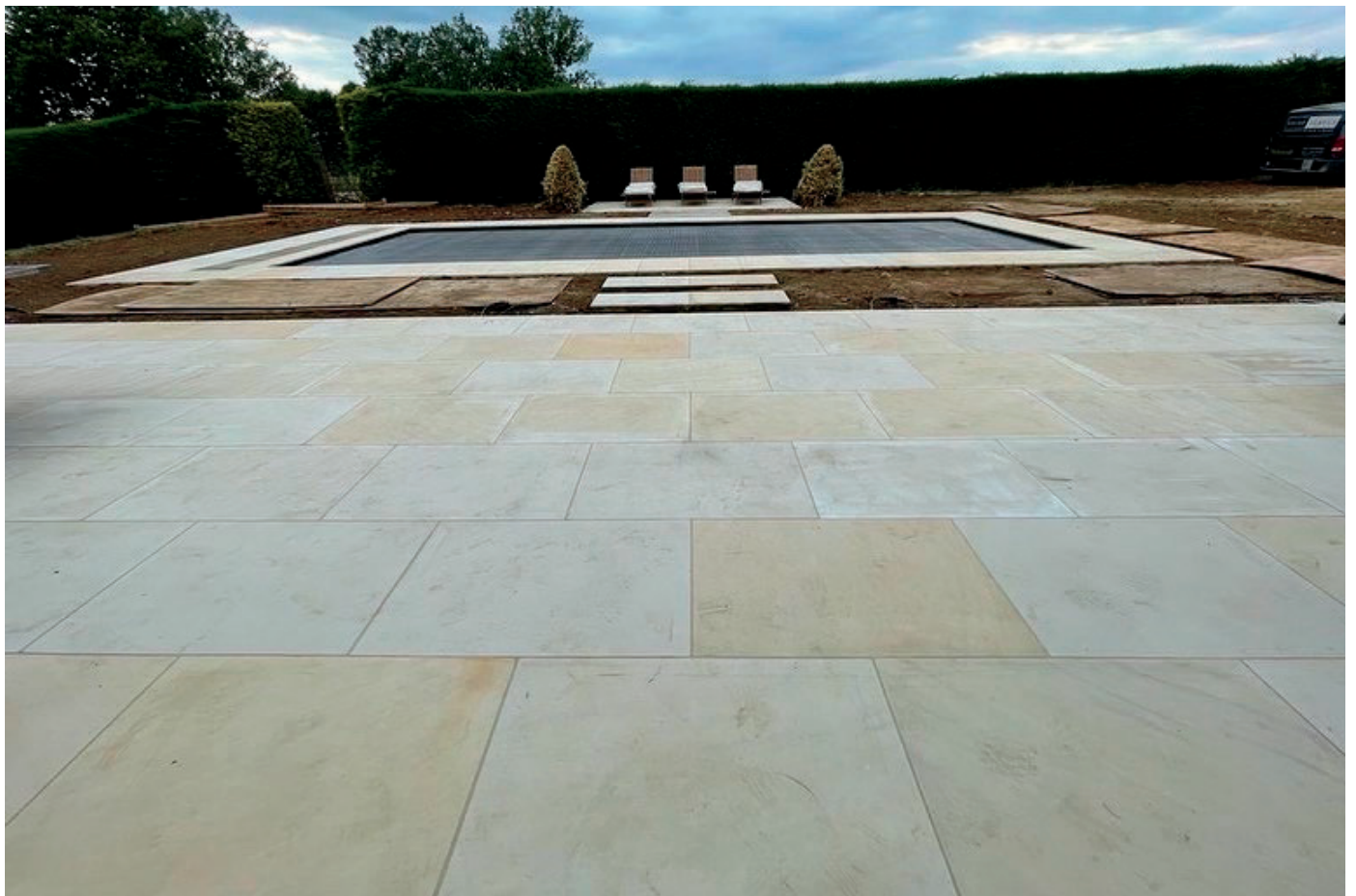



Most Popular



## LAMBELLE ANITCO

**Provenance:** Egypt

**Options Available:** 900x600x22, 600x600x22, 600x300x22, Bullnose copings, Downstand copings, Setts.

**Finish:** Acid Etch/Honed

**Slip Rating:** R9



## OLD WESTMINSTER PAVING

**Provenance:** India

**Options Available:** 560x(5)Lengthsx22

**Finish:** Riven/Polished

**Slip Rating:** R11



## IVORY MINT HONED

**Provenance:** India

**Options Available:** 900x600x22, 600x600x22, Bullnose copings.

**Finish:** Honed

**Slip Rating:** R11



## LAMBELLE GREY

**Provenance:** Egypt

**Options Available:** 900x600x22, 600x600x22, Bullnose copings, Downstand copings.

**Finish:** Acid Etch/Honed

**Slip Rating:** R9



## DINTON GREY RIVEN SANDSTONE

**Provenance:** India

**Options Available:** 900x600x22, Project packs, Bullnose copings.

**Finish:** Riven

**Slip Rating:** R13



## KOTA PURBECK PAVING

**Provenance:** India

**Options Available:** 900x600x22, Project packs, Bullnose copings.

**Finish:** Riven

**Slip Rating:** R13

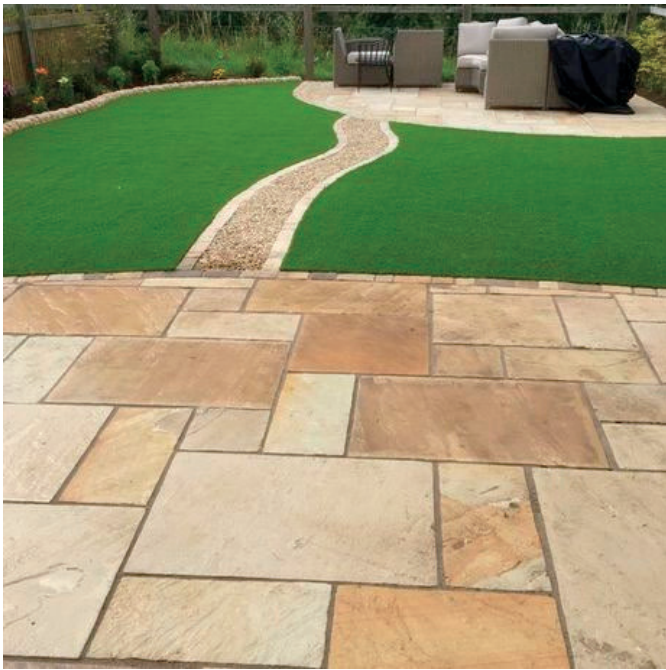



## WINDSOR TUMBLED SETTS

**Provenance:** India

**Options Available:** 150x200/250/300 /350x30-50

**Finish:** Riven/Tumbled

**Slip Rating:** R11

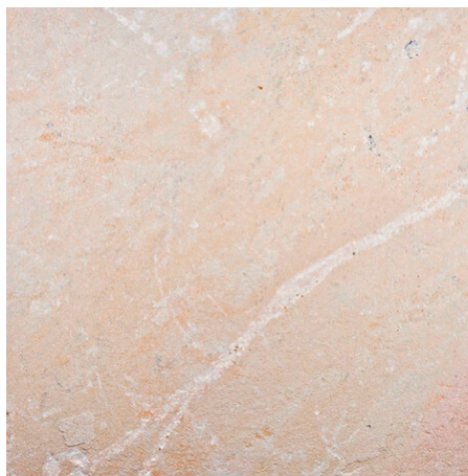

## COTSWOLD BUFF RIVEN SANDSTONE

**Provenance:** India

**Options Available:** 900x600x22, Project packs, Bullnose copings.

**Finish:** Riven

**Slip Rating:** R13



## WELLS OCRA RIVEN SANDSTONE

**Provenance:** India

**Options Available:** 900x600x22, Project packs, Bullnose copings.

**Finish:** Riven

**Slip Rating:** R13

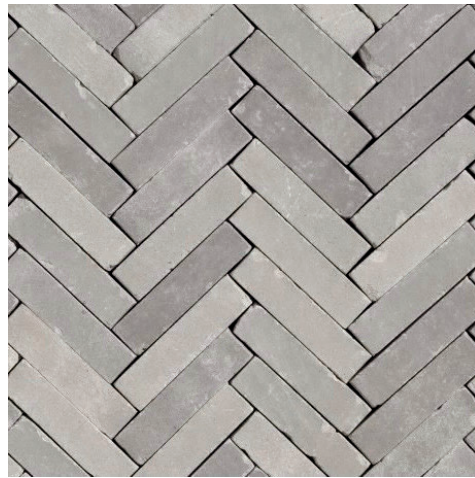

## TUMBLED STONE PAVERS

**Colours:** Raj Sawn, Raj Riven, Kandla Sawn, Kandla Riven, Ivory Mint Sawn, AC Pearl & Lambelle

**Size:** 200x40x50

**Finish:** Tumbled

**Slip Rating:** N/A



# SWIMMING POOL COPINGS

by **BASE**

We have quickly established ourselves as the leading supplier of swimming pool copings. With huge stock of both natural stone and porcelain copings, lead times are as short as 3 working days from order, but with our bespoke masonry service we're also able to offer; roman end, corners, deck levels, skimmer lids and so much more.



# PORCELAIN



Most Popular



### CASTELLO GRIGIO POOL COPING

**Size:** 1200x330x20

**Stocked Edge Detail:** Bullnose

**Bespoke:** Corners, Roman End, Deck Level, Downstand, Pencil Roll

**Matching Paving:** 1200x600x20

**Finish:** Matt

**Slip Rating:** R11

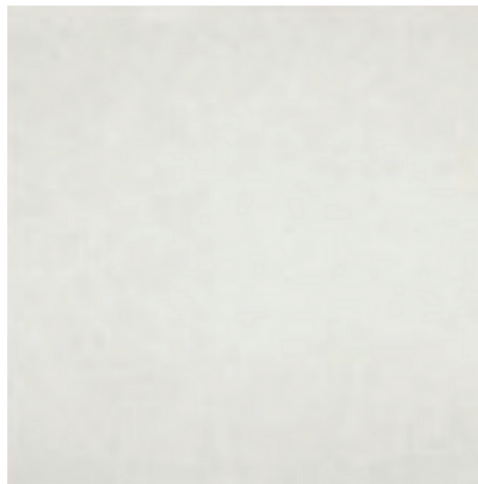
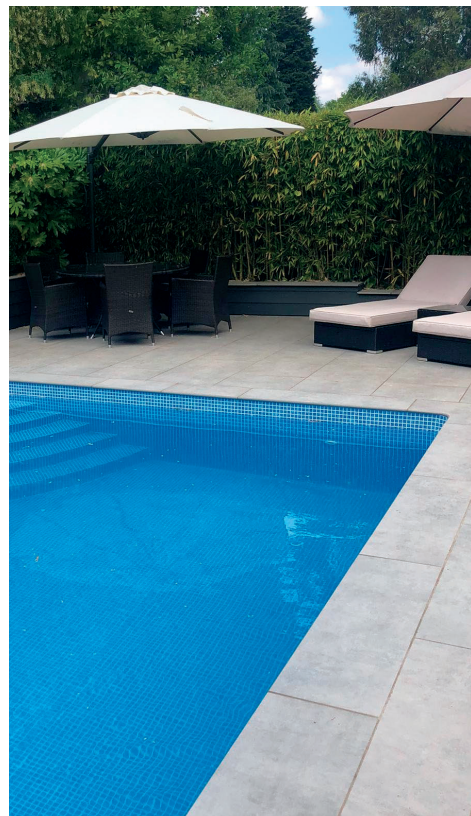

### FLORENCE WHITE POOL COPING

**Size:** 900x330x20

**Stocked Edge Detail:** Bullnose

**Bespoke:** Corners, Roman End, Deck Level, Downstand, Pencil Roll

**Matching Paving:** 900x600x20

**Finish:** Matt

**Slip Rating:** R11



Most Viewed



### MURANO DARK POOL COPING

**Size:** 600x350x20

**Stocked Edge Detail:** Bullnose, Downstand

**Bespoke:** Corners, Roman End, Deck Level, Downstand, Pencil Roll

**Matching Paving:** 900x600x20, 600x600x20

**Finish:** Matt

**Slip Rating:** R11

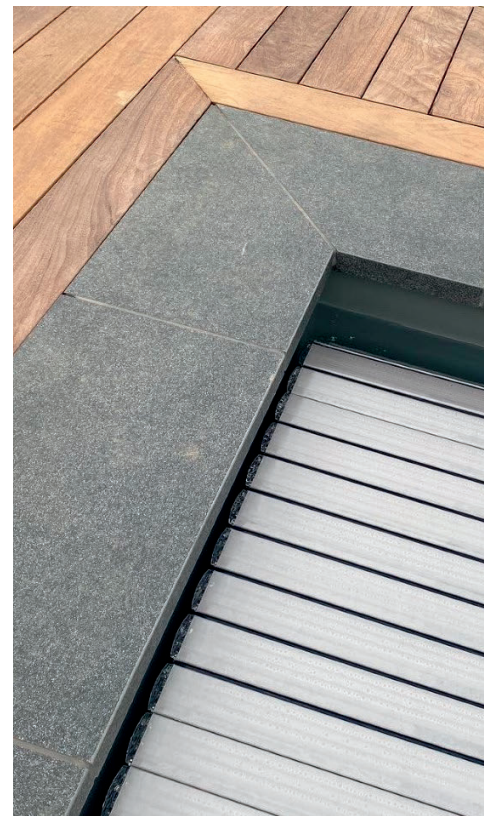



## CIATNA ANTHRACITE POOL COPING

**Size:** 900x330x20

**Stocked Edge Detail:** Bullnose

**Bespoke:** Corners, Roman End,  
Deck Level, Downstand, Pencil Roll

**Matching Paving:** 900x600x20,  
600x600x20

**Finish:** Matt

**Slip Rating:** R11



## CEMENTO DARK POOL COPING

**Size:** 900x330x20

**Stocked Edge Detail:** Bullnose

**Bespoke:** Corners, Roman End,  
Deck Level, Downstand, Pencil Roll

**Matching Paving:** 900x600x20,  
600x600x20

**Finish:** Matt

**Slip Rating:** R11



## ST.MARKS GRIGIO POOL COPING

**Size:** 600x350x20

**Stocked Edge Detail:** Bullnose,  
Downstand

**Bespoke:** Corners, Roman End,  
Deck Level, Downstand, Pencil Roll

**Matching Paving:** 900x600x20,  
600x600x20

**Finish:** Matt

**Slip Rating:** R11

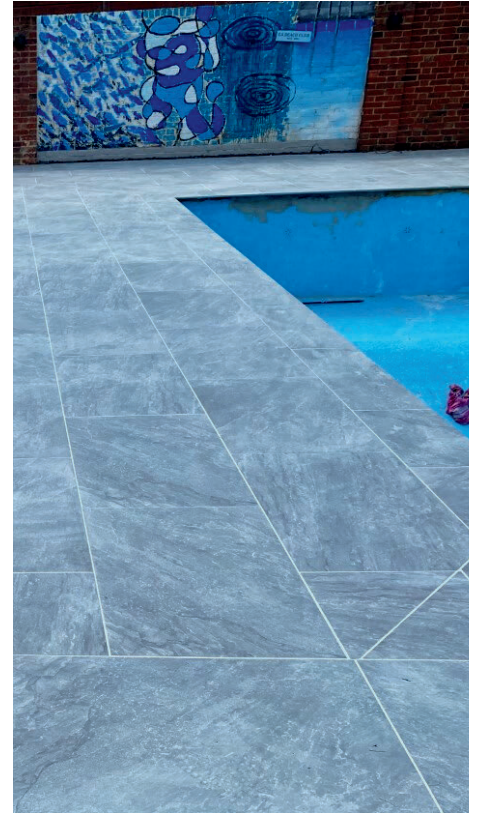
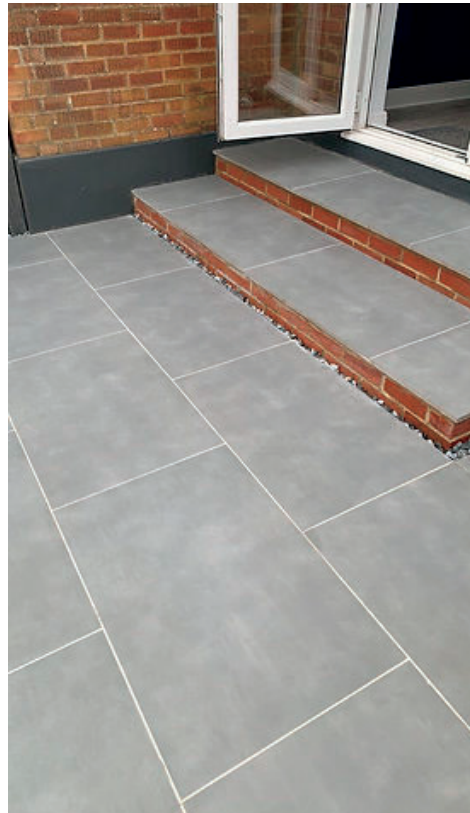





## LIASSIDI CREME POOL COPING

**Size:** 900x330x20

**Stocked Edge Detail:** Bullnose

**Bespoke:** Corners, Roman End, Deck Level, Downstand, Pencil Roll

**Matching Paving:** 900x600x20,

**Finish:** Matt

**Slip Rating:** R11



## PIAZZA GREY POOL COPING

**Size:** 600x350x20

**Stocked Edge Detail:** Bullnose, Downstand

**Bespoke:** Corners, Roman End, Deck Level, Downstand, Pencil Roll

**Matching Paving:** 900x600x20, 600x600x20

**Finish:** Matt

**Slip Rating:** R11



## BALFONT GREY POOL COPING

**Size:** 900x330x20

**Stocked Edge Detail:** Bullnose

**Bespoke:** Corners, Roman End, Deck Level, Downstand, Pencil Roll

**Matching Paving:** 900x600x20, 600x600x20

**Finish:** Matt

**Slip Rating:** R11

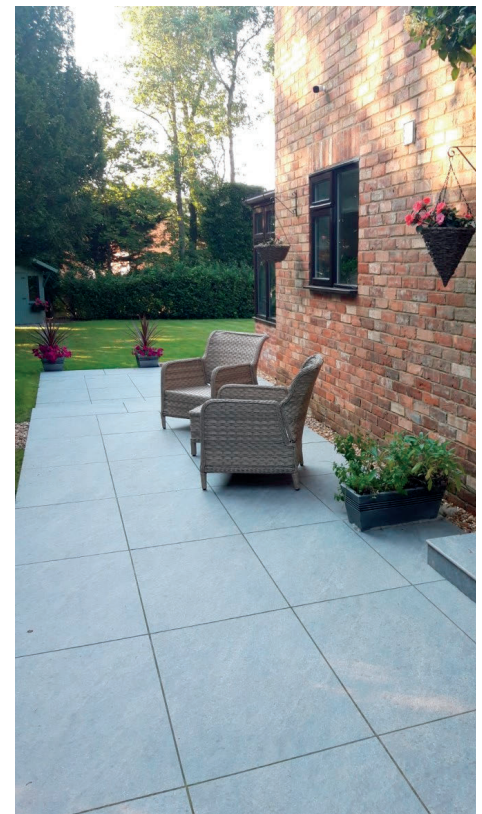

Our porcelain pool copings create the most luxurious pool surrounds available in the UK market. Fully vitrified and rectified, with a matt R11 anti-slip surface, makes them extremely hard wearing, meaning minimal maintenance and leaving you to enjoy your pool. The range consists of stone effect porcelains replicating natural stone surfaces such as; marble, limestone and various other materials perfectly designed for our collection. An in-house bespoke service means specially created size copings, various edge detailing options and deck level grilles are just a small selection of what our workshop can offer. Our porcelain has a lower water absorbency specifically designed for our pool customers, not to be compared with a standard one-fit-all porcelain tile!





## PIAZZA BEIGE POOL COPING

**Size:** 600x350x20

**Stocked Edge Detail:** Bullnose,  
Downstand

**Bespoke:** Corners, Roman End,  
Deck Level, Downstand, Pencil Roll

**Matching Paving:** 900x600x20,  
600x600x20

**Finish:** Matt

**Slip Rating:** R13

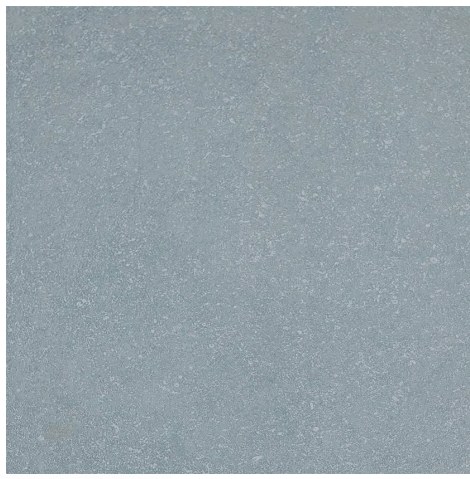

## PIAZZA BLUE POOL COPING

**Size:** 600x350x20

**Stocked Edge Detail:** Bullnose

**Bespoke:** Corners, Roman End,  
Deck Level, Downstand, Pencil Roll

**Matching Paving:** 900x600x20,  
600x600x20

**Finish:** Matt

**Slip Rating:** R13



## PEPPER GRANITE POOL COPING

**Size:** 600x350x20

**Stocked Edge Detail:** Bullnose

**Bespoke:** Corners, Roman End,  
Deck Level, Downstand, Pencil Roll

**Matching Paving:** 900x600x20,  
600x600x20

**Finish:** Matt

**Slip Rating:** R13

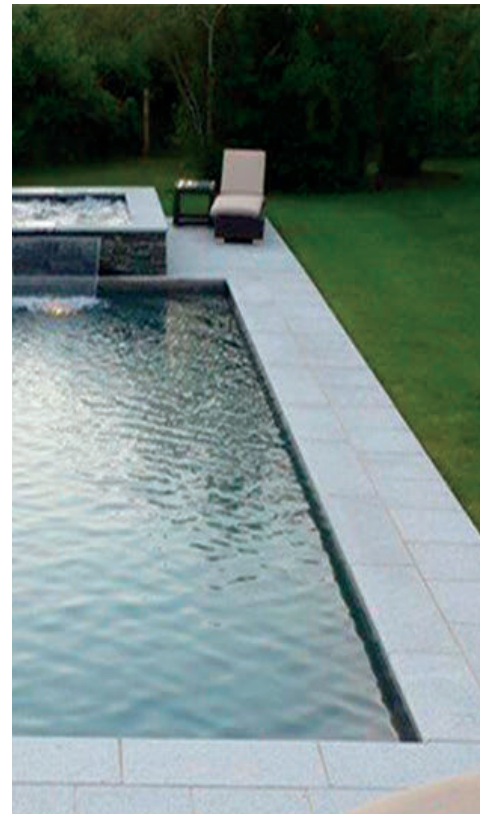



# NATURAL STONE





## LAMBELLE ANTICO POOL COPING

**Size:** 600x300x40

**Stocked Edge Detail:** Bullnose,  
Downstand

**Bespoke:** Corners, Roman End,  
Deck Level, Downstand, Pencil Roll

**Matching Paving:** 900x600x20,  
600x600x20, 600x300x20

**Finish:** Acid etch/Honed

**Slip Rating:** R9/R11

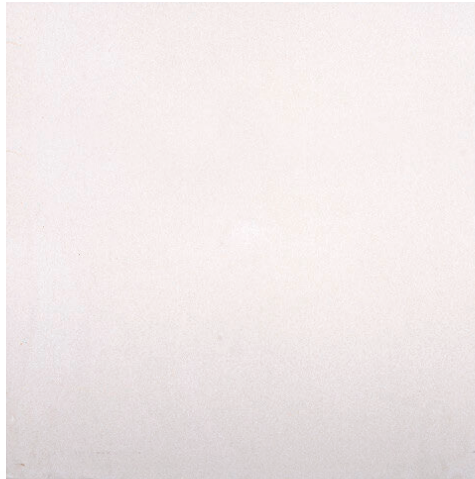

## IVORY MINT POOL COPING

**Size:** 600x400x40

**Stocked Edge Detail:** Bullnose

**Bespoke:** Corners

**Matching Paving:** 900x600x20,  
600x600x20

**Finish:** Honed

**Slip Rating:** R11



## KOTA PURBECK POOL COPING

**Size:** 600x300x40

**Stocked Edge Detail:** Bullnose

**Bespoke:** Corners

**Matching Paving:** 900x600x20,  
Project packs.

**Finish:** Riven

**Slip Rating:** R13

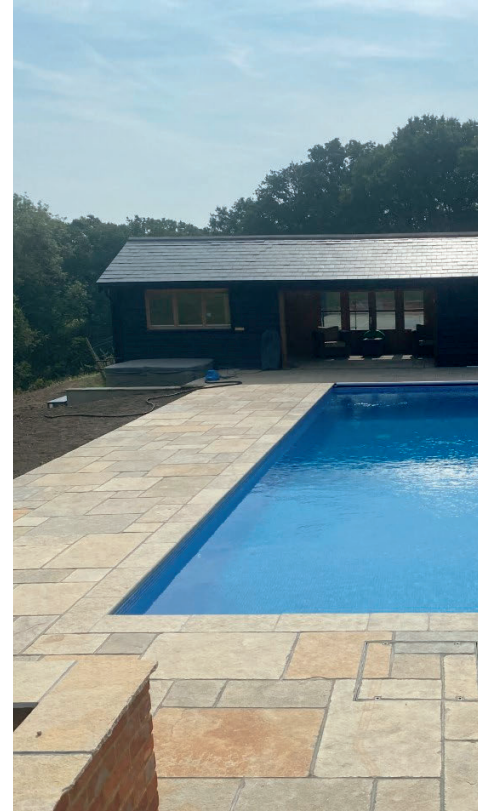
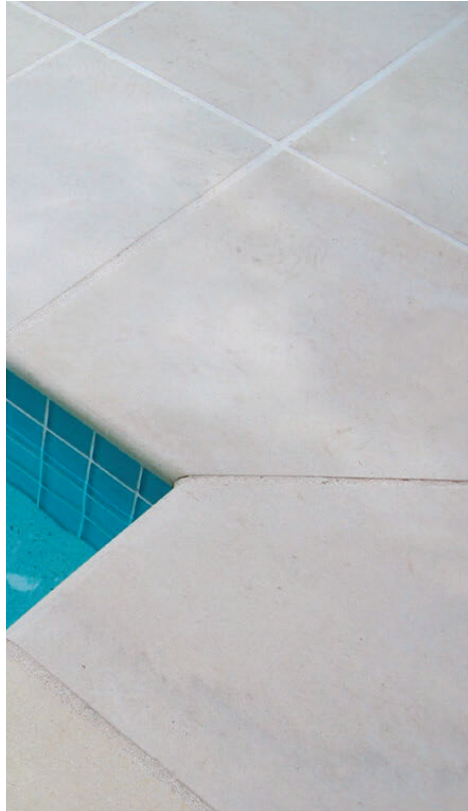



## WELLS OCRA RIVEN POOL COPING

**Size:** 600x400x40

**Stocked Edge Detail:** Bullnose

**Bespoke:** Corners

**Matching Paving:** 900x600x20,  
Project packs.

**Finish:** Riven

**Slip Rating:** R13

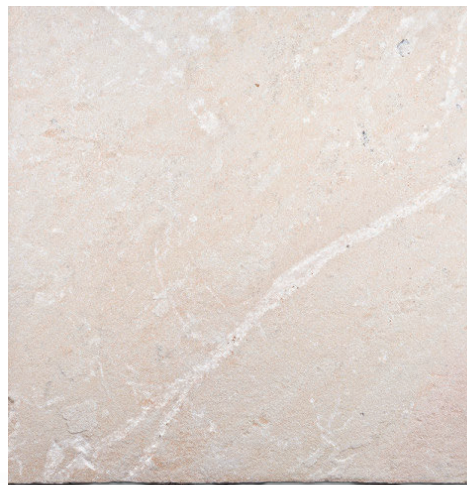

## COTSWOLD BUFF RIVEN POOL COPING

**Size:** 600x400x40

**Stocked Edge Detail:** Bullnose

**Bespoke:** Corners

**Matching Paving:** 900x600x20,  
Project packs.

**Finish:** Riven

**Slip Rating:** R13



## DINTON GREY RIVEN POOL COPING

**Size:** 600x400x40

**Stocked Edge Detail:** Bullnose

**Bespoke:** Corners

**Matching Paving:** 900x600x20,  
Project packs.

**Finish:** Riven

**Slip Rating:** R13



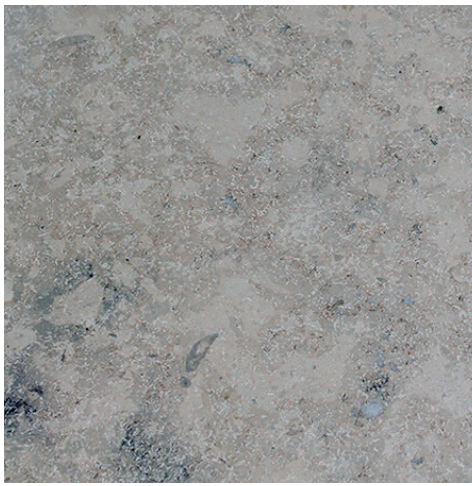

### LAMBELLE GREY POOL COPING

**Size:** 600x300x40

**Stocked Edge Detail:** Bullnose,  
Downstand

**Bespoke:** Corners

**Matching Paving:** 900x600x20,  
600x600x20

**Finish:** Acid Etch/Honed

**Slip Rating:** R9



### DINTON GREY SMOOTH POOL COPING

**Size:** 600x400x40

**Stocked Edge Detail:** Bullnose

**Bespoke:** Corners

**Matching Paving:** 900x600x20,  
Project packs.

**Finish:** Riven

**Slip Rating:** R9



### MORLEY RIVEN YORK POOL COPING

**Size:** 600x400x40

**Stocked Edge Detail:** Bullnose

**Bespoke:** Corners

**Matching Paving:** 900x600x20,  
Project packs.

**Finish:** Riven

**Slip Rating:** R13

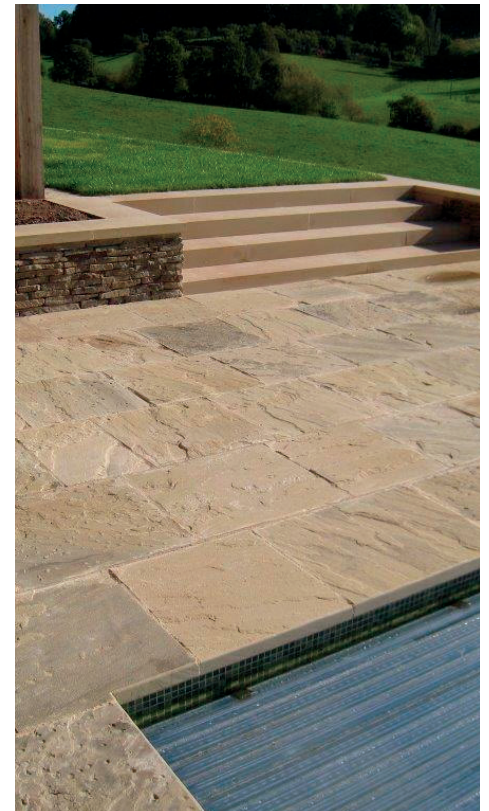



# BESPOKE

## Pool Copings

Our masonry workshop is able to create a host of products to help customers not just design but create their dream pool. We have created bespoke copings, corners, roman ends, deck levels, skimmer lids and so much more thanks to our innovative team. We also offer templating, on-site cutting services and consultancy making us the one stop shop for your pool surround!



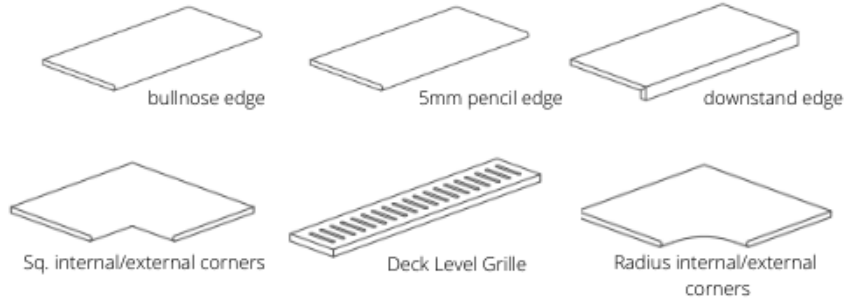





# BESPOKE MASONRY SERVICES

by **BASE**

We offer bespoke services unlike any other. With an 'in-house' masonry workshop comprising of different cutting capabilities, BASE are able to offer unlimited creativity to your project. We also offer 'on-site' services, ensuring our skilled masons are available across the UK .





Waterjet, is an industrial tool capable of cutting a wide variety of materials using an extremely high-pressure jet of water. Used mostly to cut porcelain to ensure minimal wastage and quality of cuts, the water jet also is used when cutting special shapes, grilles or grid channels. A beautiful piece of equipment to help customers achieve innovative designs.

---

We offer many different types of cutting capabilities from CNC, Still, Anec and hand tools to ensure we can help all customers achieve whatever design they're hoping to create. Speak with our sales team regarding your project and we will help you understand what is best used and why. All bespoke cutting services come with industry leading guarantees.

---



**ON-SITE MASONRY** - Not all of us are in the trade and know the radius of a corner or the diameter of a roman end, but the industry expects you to. For years bespoke work shops would require all types of information just for you to get a simple quotation. That's why we offer our stone masons direct to you, we can template, cut and finish various types of bespoke work to take the hassle out of any project.

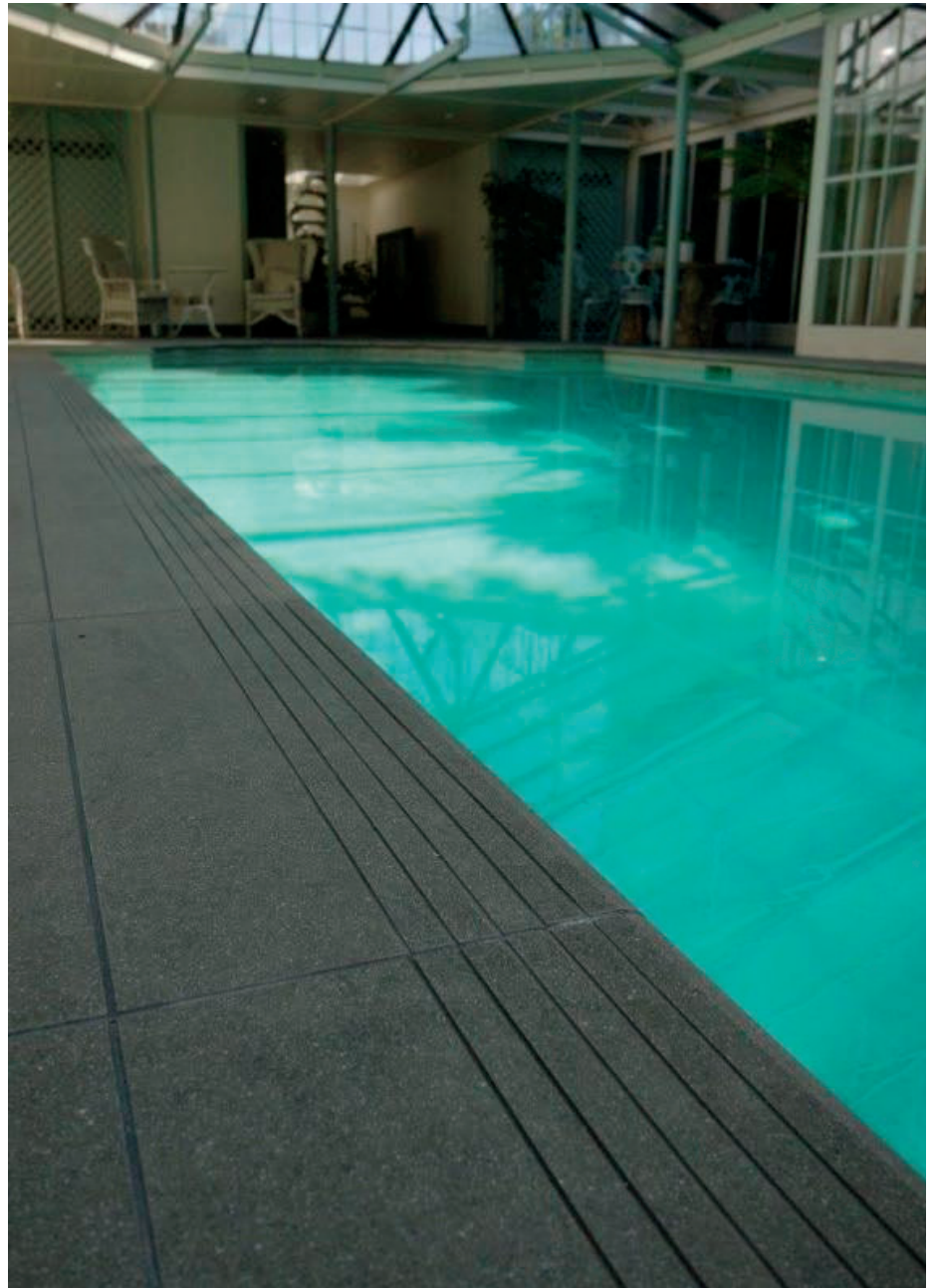
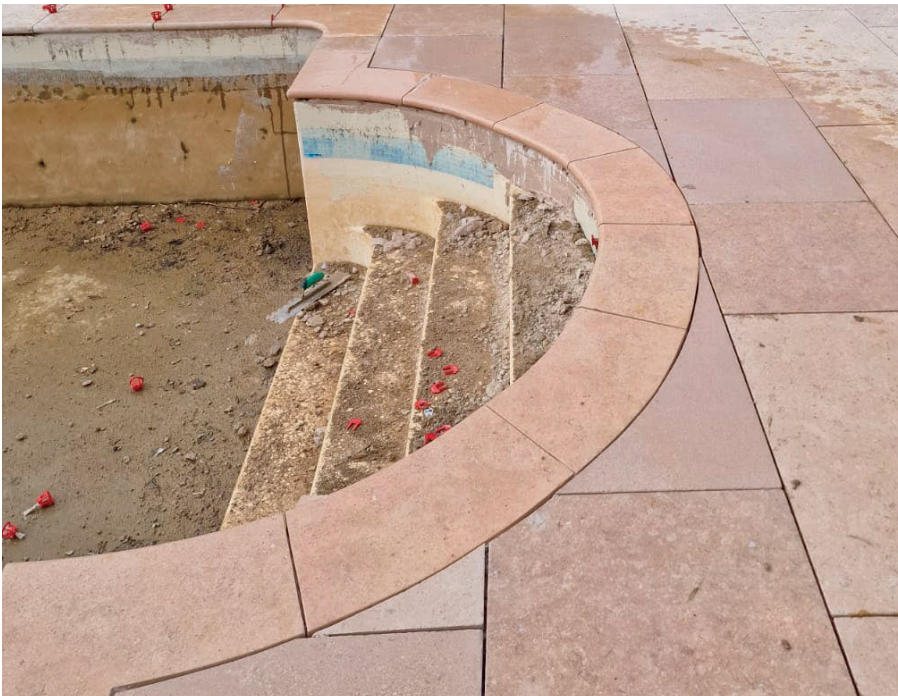



Full Bullnose



Half Bullnose

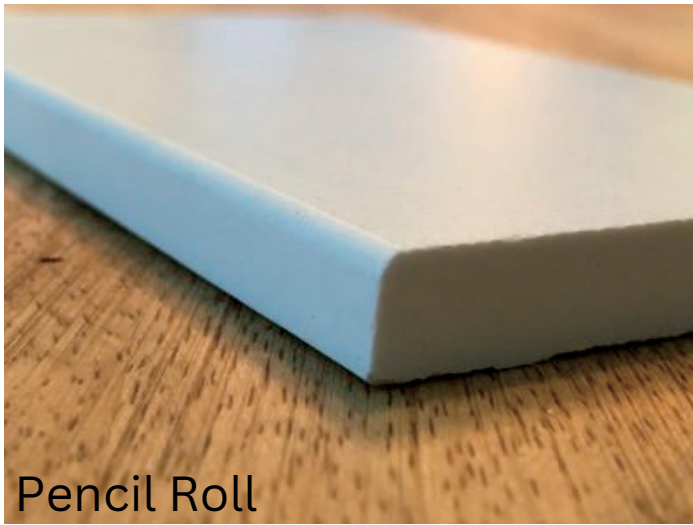

Pencil Roll

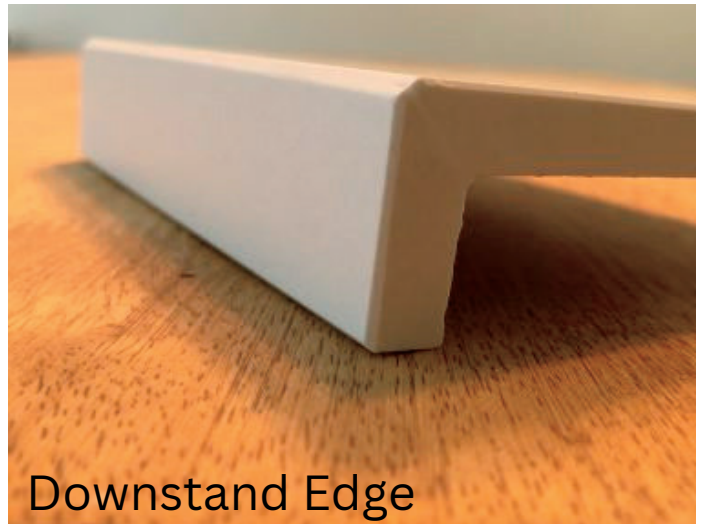

Downstand Edge

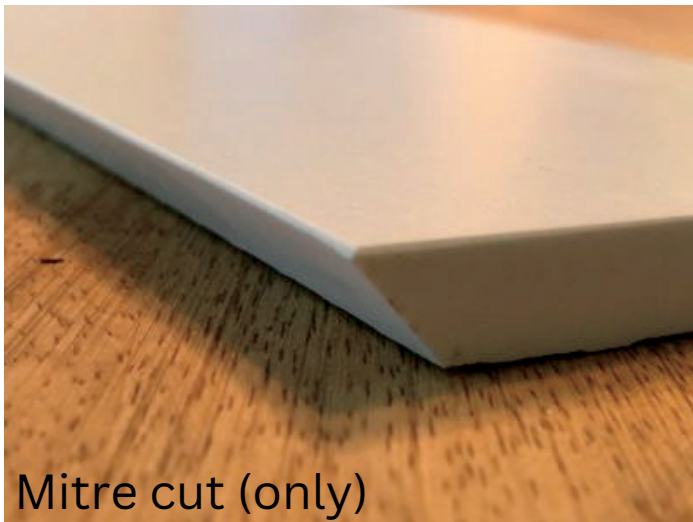

Mitre cut (only)

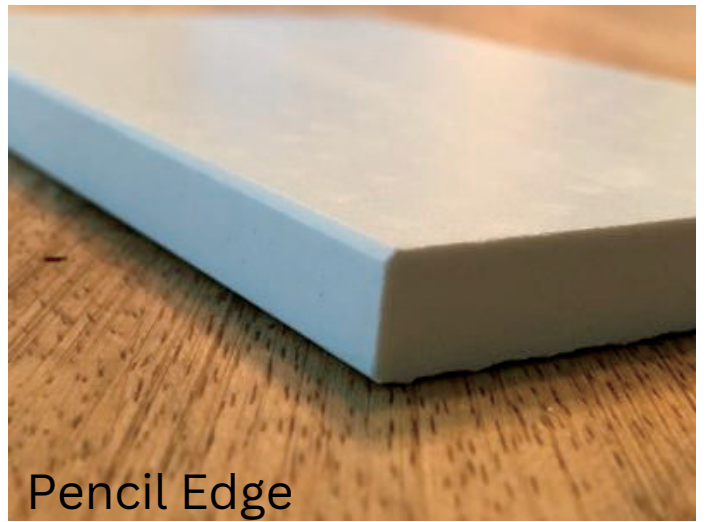

Pencil Edge

**EDGE DETAILING** - Above are the six most common edge finishes our workshop can produce, however, we also offer demi-bullnose, drip lines, anti-slip lines and an array of hand finished edge detailing for wall copings and pillars.

If you're unsure on what edge would work best for your project, then speak with our experienced team, we boast skills from masonry, fabrication, fitting and design which allows you to make informed decisions.

# INTERNAL FLOOR & WALL TILES

by **BASE**

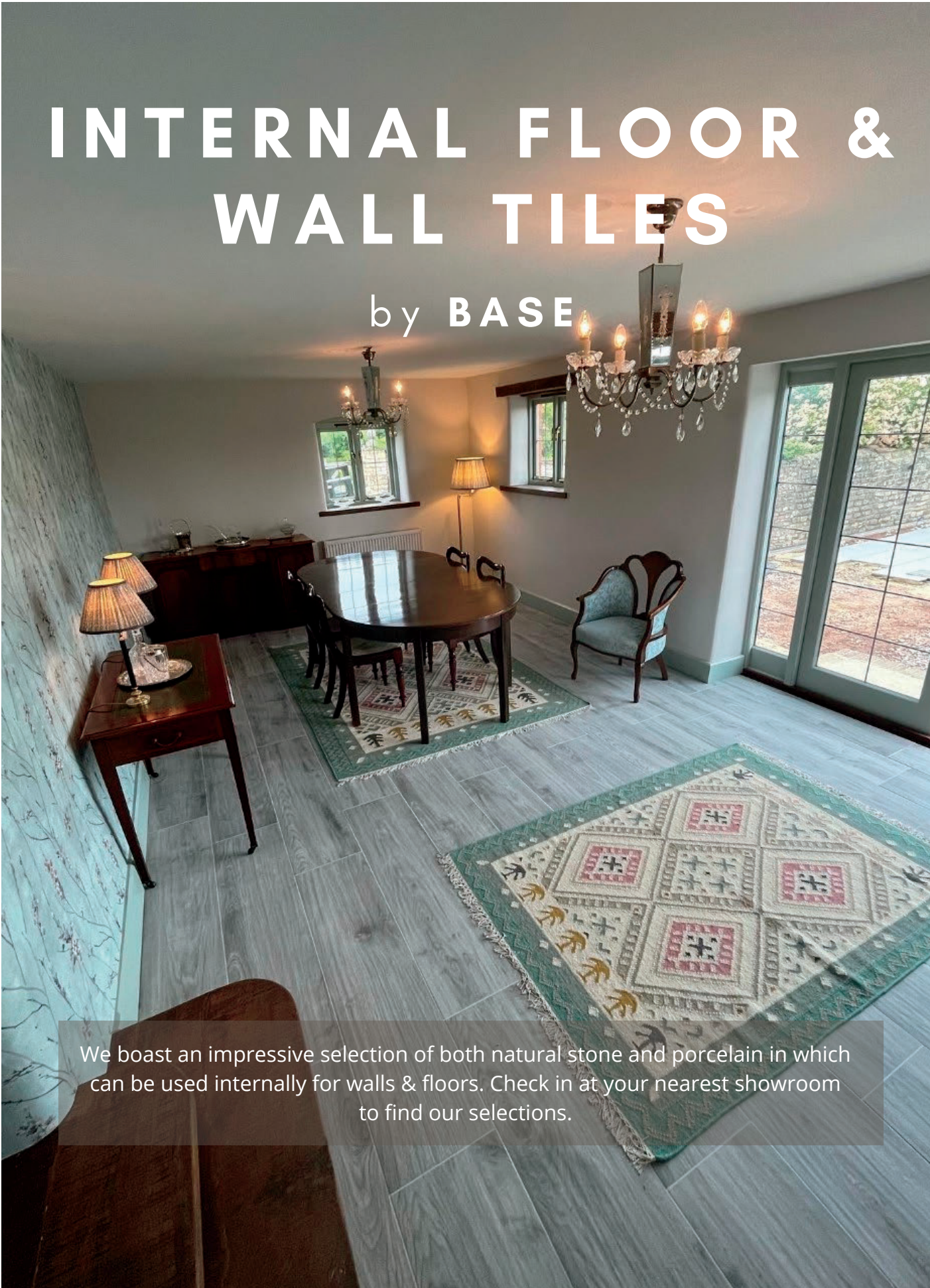

We boast an impressive selection of both natural stone and porcelain in which can be used internally for walls & floors. Check in at your nearest showroom to find our selections.



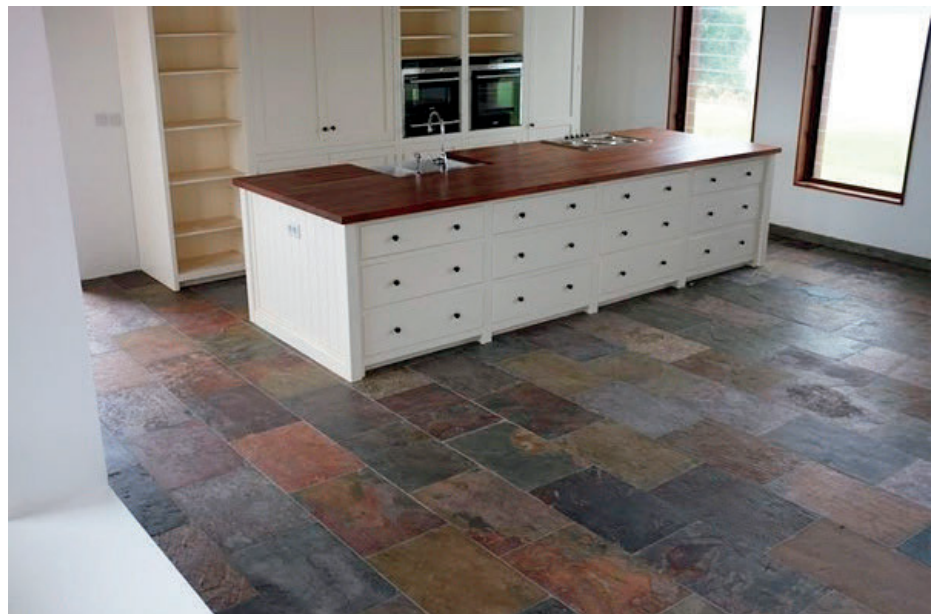
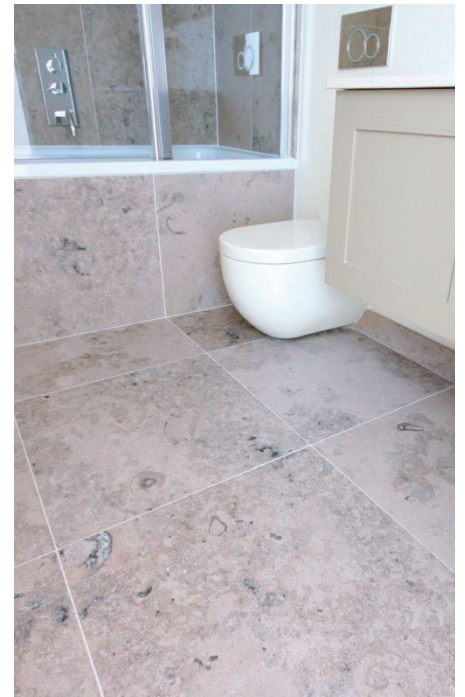

A photograph of a two-story stone building with a slate roof. The building features a mix of window styles, including a large multi-paned window on the upper left, a wooden door with a transom window, and several smaller windows. The stone is a light, warm color. The sky is clear blue.

# PRODUCT SOURCING

by **BASE**

Our variation of experience is what separates us from the competition, meaning we have a head start over everyone in sourcing products you may not see in this brochure. From reclaimed bricks, like for like porcelain, building stone, walling stone, statues and especially anything York Stone based. Speak with our team today, you never know what we may find!



# BE INSPIRED

by BASE



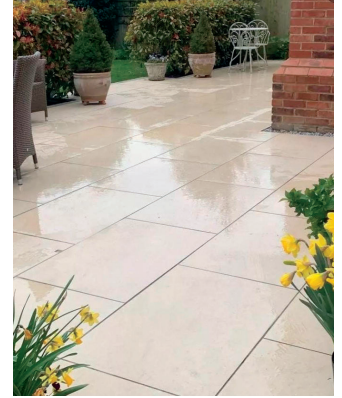

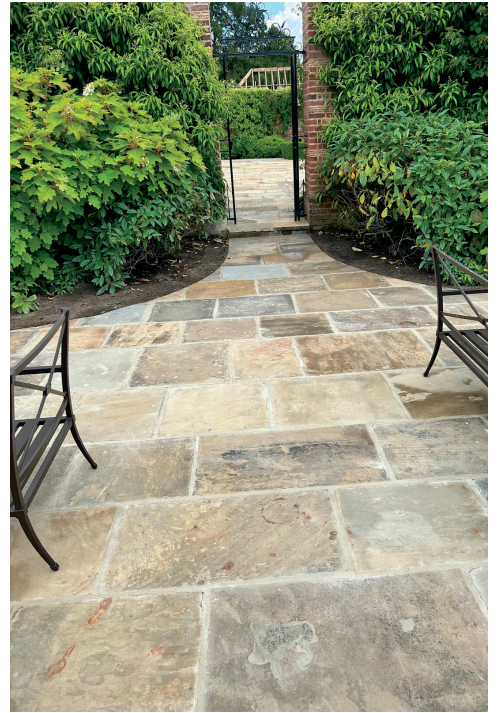
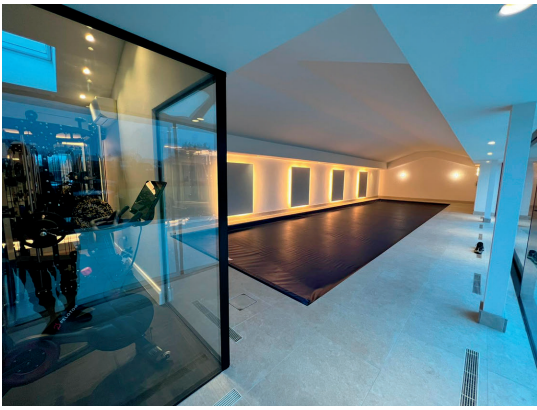

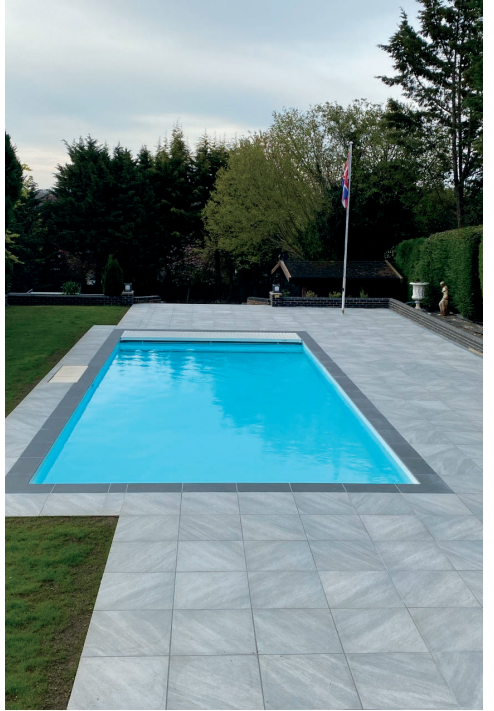

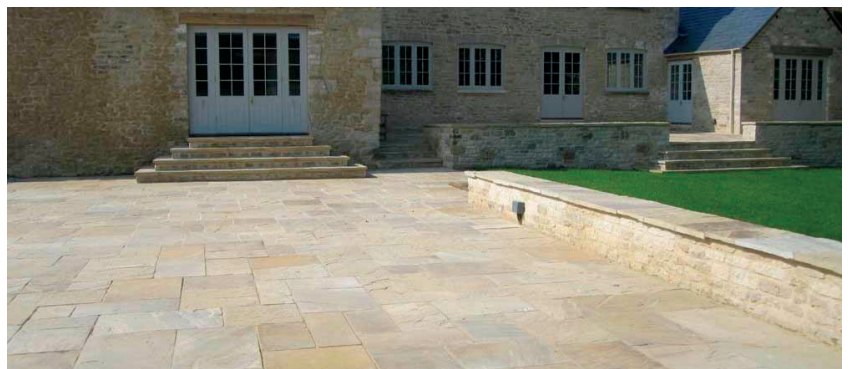





**BASE GROUP**

**2023-24**

**BASE**  
PAVING SUPPLIES



 **01235 642 700**

 **info@basepaving.co.uk**

 **www.basepaving.co.uk**

**Unit 8-10, Eyston Way, Abingdon,  
Oxfordshire, OX14 1TR**

**NATURAL STONE | PORCELAIN | BESPOKE**